



RRRB - JE



ELECTRONICS

Railway Recruitment Board

Volume - 9

Basic Electronics



CONTENTS

S.No.	Topic	Page No.
1.	Semiconductor Diodes	1 – 24
	Practice Sheet	25 – 35
2.	Bipolar Junction Transistor	36 – 50
	Practice Sheet	51 – 60
3.	Field Effect Transistors	61 – 67
	Practice Sheet	68 – 71
4.	Miscellaneous	72 – 85
	Practice Sheet	86 – 95

SEMICONDUCTOR DIODES

THEORY

1.1 SEMICONDUCTOR PHYSICS

1.1.1 Energy Bands

In gaseous substances, the arrangement of molecules is not close. In liquids, the molecular arrangement is moderate. But, in solids, the molecules are so closely arranged, that the electrons in the atoms of molecules tend to move into the orbitals of neighbouring atoms. Hence the electron orbital's overlap when the atoms come together.

Due to the intermixing of atoms in solids, instead of single energy levels, there will be bands of energy levels formed. These set of energy levels, which are closely packed are called as Energy bands.

(i) **Valance Band:** The electrons move in the atoms in certain energy levels but the energy of the electrons in the innermost shell is higher than the outermost shell electrons. The electrons that are present in the outermost shell are called as valance electrons. These valance electrons, containing a series of energy levels, form an energy band which is called as valance band. The valance band is the band having the highest occupied energy.

(ii) **Conduction Band:** The valance electrons are so loosely attached to the nucleus that even at room temperature; few of the valance electrons leave the band to be free. These are called as free electrons as they tend to move towards the neighbouring atoms. These free electrons are the ones which conduct the current in a conductor and hence called as conduction electrons. The band which contains conduction electrons is called as conduction band. The conduction band is the band having the lowest occupied energy.

(iii) **Forbidden gap:** The gap between valance band and conduction band is called as forbidden energy gap. As the name implies, this band is the forbidden one without energy. Hence no electron stays in this band. The valance electrons, while going to the conduction band, pass through this.

The following figure shows the valance band, conduction band, and the forbidden gap.

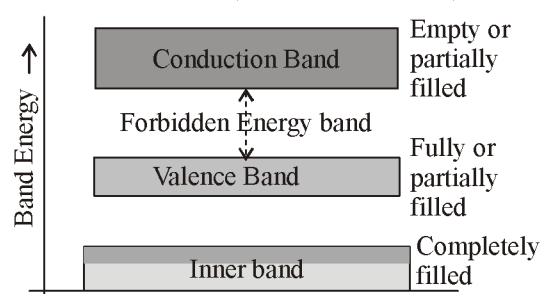

Depending upon the size of the forbidden gap, the Insulators, the Semiconductors and the Conductors are formed.

(a) **Insulators:** Insulators are such materials in which the conduction cannot take place, due to the large forbidden gap.

Ex. : Wood, Rubber.

The structure of energy bands in Insulators is as shown in the following figure.

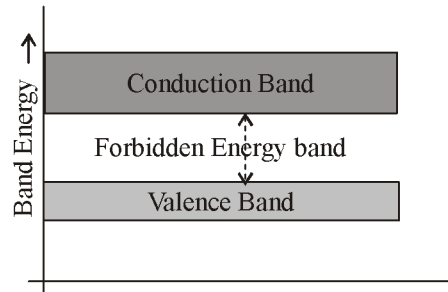

Characteristics: The following are the characteristics of Insulators.

- The Forbidden energy gap is very large.
- Valence band electrons are bound tightly to atoms.
- The value of forbidden energy gap for an insulator will be of 6 eV.
- For some insulators, as the temperature increases, they might show some conduction.
- The resistivity of an insulator will be in the order of 10^7 ohmmeter.

(b) **Semiconductors:** Semiconductors are such materials in which the forbidden energy gap is small and the conduction takes place if some external energy is applied.

Ex. : Silicon, Germanium.

The following figure shows the structure of energy bands in semiconductors.

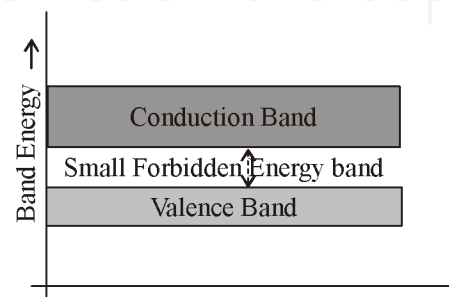

Characteristics: The following are the characteristics of Semiconductors.

- The Forbidden energy gap is very small.
- The forbidden gap for Ge is 0.7eV whereas for Si is 1.1 eV.
- A Semiconductor actually is neither an insulator, nor a good conductor.
- As the temperature increases, the conductivity of a semiconductor increases.
- The conductivity of a semiconductor will be in the order of 10^2 mhometer.

Semiconductor	Band Gap (eV)
Silicon (Si)	1.1
Germanium (Ge)	0.66
Germanium Arsenide (GaAs)	1.41
Indium Phosphate (InP)	1.34
Zinc tellurite (Zn Te)	2.26
Cudmium Tellurite (CdTe)	1.43

(c) **Conductors** : Conductors are such materials in which the forbidden energy gap disappears as the valence band and conduction band become very close that they overlap.

Ex. : Copper, Aluminium.

The following figure shows the structure of energy bands in conductors.

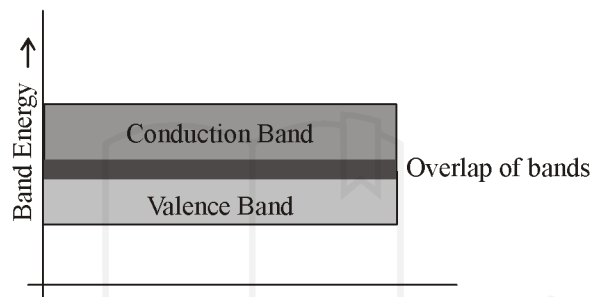

Characteristics : The following are the characteristics of Conductors.

- There exists no forbidden gap in a conductor.
- The valence band and the conduction band gets overlapped.
- The free electrons available for conduction are plenty.
- A slight increase in voltage, increases the conduction.
- There is no concept of hole formation, as a continuous flow of electrons contribute the current.

1.1.2 Fermi Level

Fermi energy is expressed in eV. Fermi energy is defined as the maximum energy possessed by an electron at 0 K.

Fermi energy is defined as the maximum kinetic energy possessed by an electron at 0 K.

$$\text{Max. KE} = \frac{1}{2}mV_{\text{max}}^2$$

$$E_F = \frac{1}{2}mV_{\text{max}}^2$$

$$\text{Max. velocity of } e^- = V_{\text{max}} = \sqrt{\frac{2E_F}{m}} \text{ m/sec}$$

Fermi energy is also defined as the energy possessed by fastest moving e^- electron at 0 K.

1.1.3 Types of Semiconductors

(i) Intrinsic Semiconductors : Also called pure semiconductor (or) non-degenerate semiconductor (as basic properties are not changed). Degenerate means change of basic properties by adding impurity. Hence extrinsic semiconductor is known as degenerate semiconductor.

The properties of this pure semiconductor are as follows

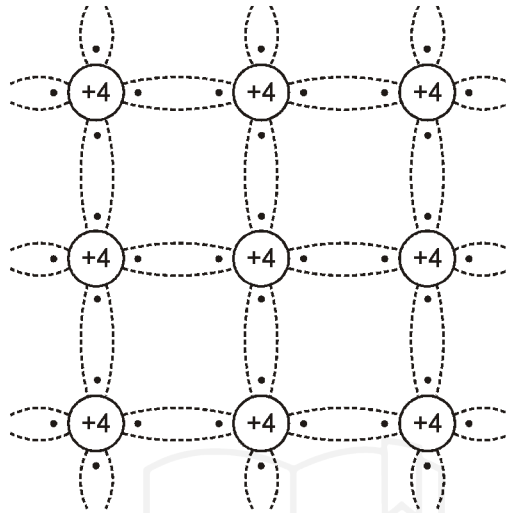

Intrinsic SC at $T = 0\text{ K}$

- The electrons and holes are solely created by thermal excitation.
- The number of free electrons is equal to the number of holes.
- The conduction capability is small at room temperature.
- Intrinsic semiconductor behaves as a perfect insulator at 0 K.
- The sharing of electrons with neighbouring atom is called covalent bonding.
- At 0 K all valence electrons are in perfect covalent bonding.
- Intrinsic semiconductor at 0 K is a perfect insulator.
- Fermi level is middle to valance band and conduction band.

In order to increase the conduction capability of intrinsic semiconductor, it is better to add some impurities. This process of adding impurities is called as Doping. Now, this doped intrinsic semiconductor is called as an Extrinsic Semiconductor.

Doping : The process of adding impurities to the semiconductor materials is termed as doping. The impurities added, are generally pentavalent and trivalent impurities.

Pentavalent Impurities : The pentavalent impurities are the ones which has five valence electrons in the outer most orbit.

Ex. : Bismuth, Antimony, Arsenic, Phosphorus

The pentavalent atom is called as a donor atom because it donates one electron to the conduction band of pure semiconductor atom.

Trivalent Impurities: The trivalent impurities are the ones which has three valence electrons in the outer most orbit.

Ex. : Gallium, Indium, Aluminum, Boron

The trivalent atom is called as an acceptor atom because it accepts one electron from the semiconductor atom.

(ii) Extrinsic Semiconductor : An impure semiconductor, which is formed by doping a pure semiconductor is called as an extrinsic semiconductor. It is also called impurity semiconductor (or) doped semiconductors (or) artificial semiconductors (or) de-generate semiconductor or compensated semiconductor. There are two types of extrinsic semiconductors depending upon the type of impurity added. They are N-type extrinsic semiconductor and P-Type extrinsic semiconductor.

- (a) N-Type Extrinsic Semiconductor :** A small amount of pentavalent impurity is added to a pure semiconductor to result in N-type extrinsic Semiconductor. The added impurity has 5 valence electrons. For example, if pentavalent atom is added to the semiconductor atom, four of the valence electrons get attached with the Ge atoms while one electron remains as a free electron. This is as shown in the following figure.

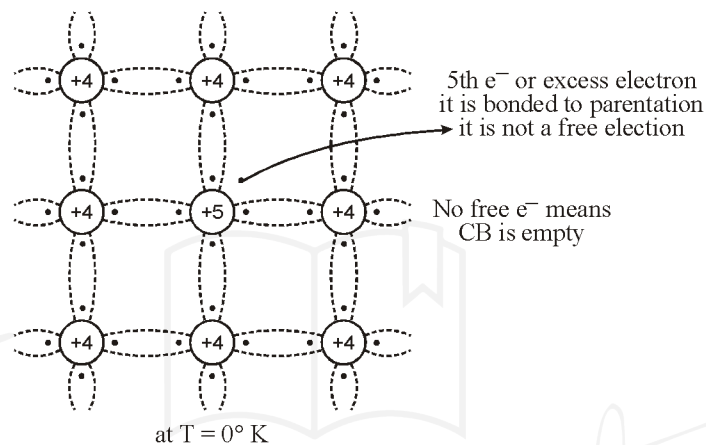

All of these free electrons constitute electron current. Hence, the impurity when added to pure semiconductor, provides electrons for conduction.

- In N-type extrinsic semiconductor, as the conduction takes place through electrons, the electrons are majority carriers and the holes are minority carriers.
- As there is no addition of positive or negative charges, the electrons are electrically neutral.
- When an electric field is applied to an N-type semiconductor, to which a pentavalent impurity is added, the free electrons travel towards positive electrode. This is called as negative or N-type conductivity.
- The minimum energy required to conduction in N-Type Ge is 0.01 eV.
- The minimum energy required to conduction in N-Type Si is 0.05 eV.
- N-Type semiconductor at 0 K is a perfect insulator.
- Fermi level is near to conduction band.

- (b) P-Type Extrinsic Semiconductor :** A small amount of trivalent impurity is added to a pure semiconductor to result in P-type extrinsic semiconductor. The added impurity has 3 valence electrons. For example, if trivalent atom is added to the semiconductor atom, three of the valence electrons get attached with the semiconductor atoms, to form three covalent bonds. But, one more electron in semiconductor remains without forming any bond. As there is no electron in trivalent atom remaining to form a covalent bond, the space is treated as a hole. This is as shown in the following figure.

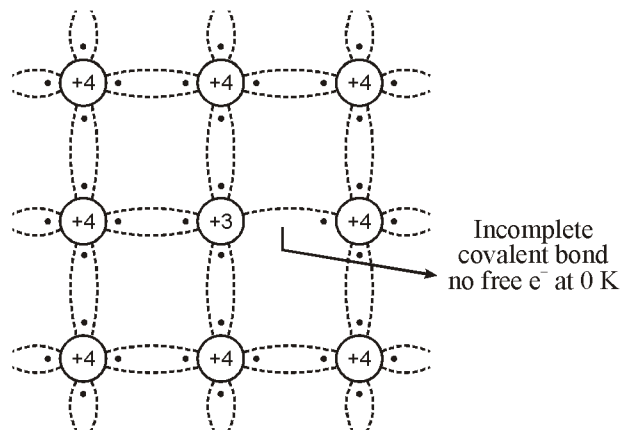

The boron impurity when added in a small amount, provides a number of holes which helps in the conduction. All of these holes constitute hole current.

- In P-type extrinsic semiconductor, as the conduction takes place through holes, the holes are majority carriers while the electrons are minority carriers.
- The impurity added here provides holes which are called as acceptors, because they accept electrons from the germanium atoms.
- As the number of mobile holes remains equal to the number of acceptors, the P-type semiconductor remains electrically neutral.
- When an electric field is applied to a P-type semiconductor, to which a trivalent impurity is added, the holes travel towards negative electrode, but with a slow pace than electrons. This is called as P-type conductivity. In this P-type conductivity, the valence electrons move from one covalent bond to another, unlike N-type.
- The minimum energy required to conduction in P-Type Ge is 0.01 eV.
- The minimum energy required to conduction in P-Type Si is 0.05 eV.
- P-Type semiconductor at 0 K is a perfect insulator.
- Fermi level is near to valance band.

Note:

Why Silicon is Preferred in Semiconductors?

Among the semiconductor materials like germanium and silicon, the extensively used material for manufacturing various electronic components is Silicon. Silicon is preferred over germanium for many reasons such as

- The energy band gap is 0.7 eV, whereas it is 0.2 eV for germanium.
- The thermal pair generation is smaller.
- The formation of SiO₂ layer is easy for silicon, which helps in the manufacture of many components along with integration technology.
- Si is easily found in nature than Ge.
- Noise is less in components made up of Si than in Ge.

1.1.4 Mass-Action Law

In a semiconductor (intrinsic and extrinsic) under thermal equilibrium the product of e^- holes is always a constant and is equal to the square of intrinsic concentration.

$$n \cdot p = n_i^2$$

where n = concentration of e^-
 p = concentration of holes
 n_i = intrinsic concentration

(i) For N-type semiconductor

Mass-action law is given by

$$n_n p_n = n_i^2$$

where n_n = concentration of e^-
 p_n = concentration of holes

For n-type materials concentration of e^- is almost equal to the donor concentration.

$\therefore n_n \approx N_D$

$$N_D p_n = n_i^2$$

$$p_n = \frac{n_i^2}{N_D}$$

(ii) For p-type semiconductor

Mass action law is given by

$$n_p p_p = n_i^2$$

where n_p = concentration of e^-
 p_p = concentration of holes

For p-type materials concentration of e^- is almost equal to the acceptor concentration

$$n_p \approx n_A$$

$$N_p \cdot N_A = n_i^2$$

$$N_p = \frac{n_i^2}{N_A}$$

1.1.5 Direct and Indirect Band gap semiconductors

(i) **Direct Band-Gap semiconductor** : In this type of semiconductor electrons from excited state in conduction band jump directly to valence band.

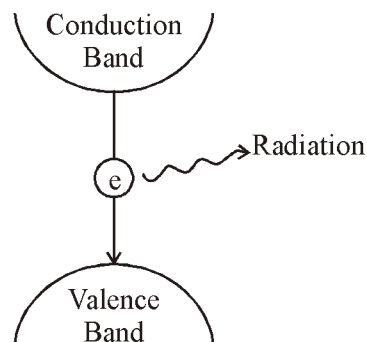

While jumping from conduction band to valence band the electron loose an energy, equal to the band gap in the form of radiation.

$$h\nu = E_G$$

where h = plank constant = 6.626×10^{-34} JS
 ν = frequency of radiation

$$\nu = \frac{c}{\lambda}$$

where c = velocity of light = 3×10^8 m/s
 λ = wave length

$$\frac{hc}{\lambda} = E_G$$

$$\lambda = \frac{hc}{E_G} \Rightarrow \lambda = \frac{1.24}{E_G} \mu\text{m}$$

where λ in μm and E_G in eV.

Ex. : GaAs

Note : In this most of the falling e^- from conduction band to valence band will be directly releasing energy in form of light (99%) and very few e^- while falling from conduction band to valence band will collide with the crystal of atoms and these crystal will be absorbing the energy from the falling electrons and gets heated up and they will release energy in form of heat (1%).

(ii) Indirect Band-Gap : The semiconductor in which electrons from conduction band do not jump directly to valence band rather first jump from conduction band to some intermediate energy level called defect level and then from intermediate energy level to valence band are called indirect band gap.

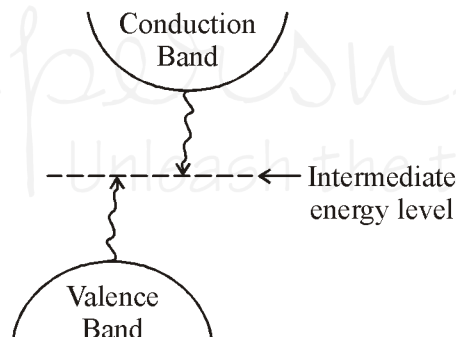

Ex. : Ge and Si

Note : In Indirect Band Gap semiconductor most of the falling electrons from conduction band to valence band will collide with the crystal of the atom and these crystal will be absorbing the energy from the falling electron and gets heated up and they will release energy in the form of heat (99%) and very few electrons falling on conduction band to valence band will directly falling and they will release energy in form of light (1%).

1.1.6 Einstein's Equation

It gives the relation between diffusion constant, mobility and thermal voltage.

$$\frac{D_n}{\mu_n} = \frac{D_p}{\mu_p} = \frac{KT}{q} = V_T = \frac{T}{11600}$$

Thermal voltage $V_T = \frac{KT}{q}$

1.1.7 Hall Effect

Hall effect states that : “If a specimen (metal or semiconductor) carrying the current I is placed in transverse magnetic field B, an electric field intensity E is induced in a direction perpendicular to both I and B”.

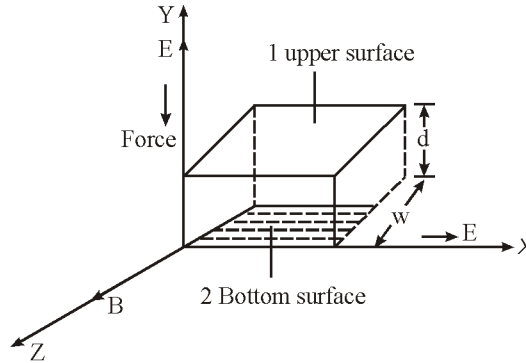

Where w is the width of specimen d is the height or thickness of the specimen (or) spacing between bottom surface and upper surface of specimen.

Representation of Hall voltage

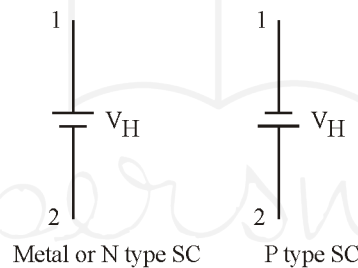

Hall effect can be used to determine :

- Whether the given specimen is a metal or semiconductor.
- The concentration of charge carrier in the specimen.
- Mobility of charge carrier.
- To measure the signal power in EM wave.
- In designing of hall effect transducer.

1.2 PN-JUNCTION

If we join a piece of P-type semiconductor to a piece of N-type semiconductor such that the crystal structure remains continuous at boundary. PN junction or diode as shown in figure.

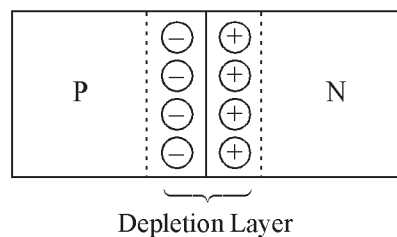

P-type region doped with acceptor type impurity have holes in majority and N-type region doped with donor type impurity have electrons in majority. When P-type and N-type piece are combined, electrons from N-side and holes from P-side diffused towards junction and disappear in the form of heat after neutralizing each other. In this process electrons from N-side and holes from P-side leaves the immobile positive and negative ions respectively. The region from where mobile charges have been depleted is called 'Depletion region'. Depletion region contains fixed rows of oppositely charged ions (immobile charge) on its two sides. These immobile opposite charges due to ions develops an electric potential. This potential is called barrier or junction potential V_B . Barrier potential is given by the relation :

$$V_B = V_T \ln \frac{N_A N_D}{n_i^2}$$

Where $V_T = \frac{T}{11600}$ (volt equivalent of temperature)

N_A = concentration of acceptors (/cm³) on P-side

N_D = concentration of donors (/cm³) on N-side

n_i = Intrinsic concentration (/cm³) at given temperature

$V_B = 0.3V$ for Ge }
 $V_B = 0.7V$ for Si } at room temperature

Built in potential in diode is given by :

$$V_B = V_T \ln \frac{N_A N_D}{n_i^2}$$

Applying voltage across a PN junction : The potential difference across a PN junction can be applied in two ways i.e. Reverse biasing and Forward biasing.

- (i) **Reverse Biasing :** In reverse biasing, P-side is connected to negative terminal of the battery and N-side is connected to positive terminal of the battery. This type of biasing increases the depletion width

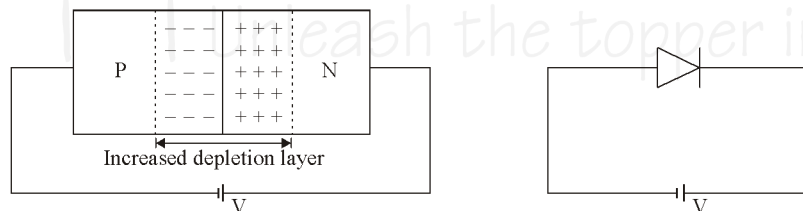

Only very small reverse saturation current flows which is truly temperature dependent. It does not depend on the amplitude of applied voltage.

Reverse saturation current or leakage current

$$I_0 = qA \left(\frac{D_P}{L_P N_D} + \frac{D_N}{L_N N_P} \right) n_i^2$$

$$I_0 \propto A$$

where, A = area of cross section

D_P, D_N = diffusion constant of holes and electrons respectively

L_P, L_N = diffusion length of holes and electrons respectively

Hence reverse saturation current is proportional to the area of junction.

Reverse Bias Diode has

- (i) High resistance
 - (ii) Very small reverse saturation current
 - (iii) Large depletion width.
- (ii) **Forward Biasing :** In forward biasing, P-side is connected to positive terminal of the battery and N-side connected to negative terminal of battery. The current through the diode is given by the relation.

$$I_D = I_0 \left(e^{\frac{V_D}{\eta V_T}} - 1 \right) \quad \dots(i)$$

Where,

- $\eta = 1$ for Ge
- $\eta = 2$ for Si for low current
- $\eta = 1$ for Si for high current
- $V_D =$ Voltage across diode

Equation (i) may also be written as :

$$\log I_D = \frac{I_0}{\eta} \times \frac{V_D}{V_T}$$

or

$$\log I_D \propto V_D$$

The characteristic between $\log I_D$ and voltage V_D has linear variation. This is shown in figure below :

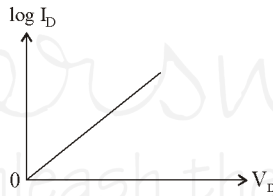
**Characteristics of Forward Bias :**

- (i) Very high current.
- (ii) Low resistance.
- (iii) Reduced depletion width.

Temperature dependency of I_0 and V_D :

- (i) The temperature and diode current in a PN junction diodes is related by the following relation:

$$I_{0(T_2)} = I_{0(T_1)} \times 2^{\frac{(T_2 - T_1)}{10}}$$

where, $I_{0(T_2)}$ = Reverse saturation current at temperature T_2
 $I_{0(T_1)}$ = Reverse saturation current at temperature T_1
 here $T_2 > T_1$

- (ii) Reverse saturation current doubles for each 10°C rise in temperature

$$\frac{dV_D}{dt} = -2.5 \text{ mV}/^\circ\text{C}$$

- (iii) Voltage across diode reduces by 25 mV for each 10°C increase in temperature.

V–I Characteristic : Volt-ampere characteristic of a diode is the curve between voltage across the junction and current through the circuit. V–I characteristic of a PN junction diode is shown below :

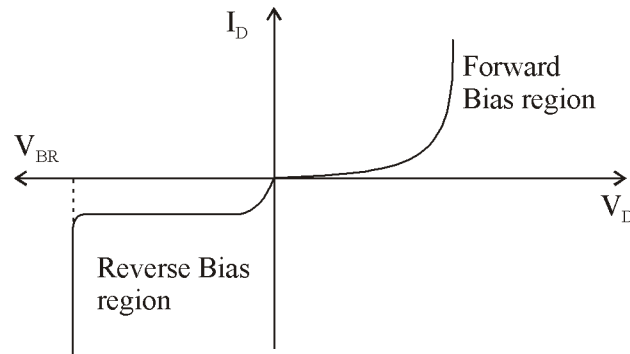

Breakdown voltage (V_{BR}) : It is the reverse voltage at which PN Junction breaks down with sudden rise in reverse current.

Knee voltage : It is the forward voltage at which the current through the junction starts to increase rapidly.

Capacitance of diode : In a PN junction semiconductor diode, there exists two capacitance effects. They are :

- Space charge or transition capacitance (in reverse bias region)
- Diffusion capacitance (in forward bias region)

Space charge or Transition Capacitance (C_T) : In the reverse bias region, we have the space charge capacitance, C_T is defined as :

$$C_T = \left| \frac{dQ}{dV} \right|$$

where dQ is the increase in charge caused by a change dV in voltage. The thickness of space charge layer at the junction increases with reverse voltage.

The capacitance C_T depend on the magnitude of the reverse voltage.

Transition capacitance dominant in reverse bias, it is due to uncovered charge gone,

$$C_T = \frac{\epsilon A}{w}$$

Where , ϵ = permittivity, A = area

w = width of depletion layer

$$V_j = \frac{qN_A w^2}{2\epsilon} \text{ for step or abrupt junction}$$

When $N_D \gg N_A$

$$V_j = \frac{qN_A w^3}{2\epsilon} \text{ for linearly graded junction}$$

Where, V_j = junction voltage under reverse bias

Hence

$$C_T \propto V_j^{-1/2} \text{ (for step graded)}$$

$$C_T \propto V_j^{-1/3} \text{ (for linearly graded)}$$

Diffusion Capacitance : When diode is connected in forward bias the capacitance observed is called Diffusion Capacitance. It can be divided in two categories.

- (a) **Static Diffusion Capacitance** : It is the diffusion capacitance when diode is connected with DC voltage and it is due to storage of charge in the junction under forward bias.

The static diffusion capacitance is given by :

$$C_D = \frac{dQ}{dV} = \tau \frac{dI}{dV} = \tau g = \frac{\tau}{r_d} \quad \left[\because g = \frac{1}{r_d} \right]$$

Where,

$$r_d = \frac{\eta V_T}{I} \quad \text{and} \quad \tau = \frac{L^2}{D}$$

L = diffusion length

D = diffusion constant

τ = lifetime of electrons and holes

$$\therefore C_D = \frac{\tau}{\eta r_d}$$

Where diode resistance $r_d = \frac{V_D}{I_D}$

- (b) **Dynamic diffusion capacitance**

It is the capacitance when AC signal is applied at the input of the diode.

Dynamic capacitance for sinusoidal input is given by :

$$C'_D = \frac{1}{2} \tau g, \text{ if } \omega \tau \ll 1 \text{ for small frequency}$$

$$C'_D = \left(\frac{\tau}{2\omega} \right)^{1/2} g, \text{ if } \omega \tau \ll 1 \text{ for higher frequency}$$

Note :

- The characteristic between $\log_e I_D$ and V_D is a straight line.
- In forward biased, diffusion capacitance is higher than transition capacitance.
- In reverse biased, transition capacitance is higher than diffusion capacitance.

Type of Breakdown : There are two types of breakdown :

- (a) **Zener breakdown** : Heavily doped junction has narrow depletion layer therefore when reverse voltage increase, the strong electric field may cause rupture of covalent bond structure as a result of which very large current flows through the junction. For heavily doped, zener breakdown occurs at electric field of 2×10^7 V/m approximately. This value of electric field is reached at voltages below about 6V for heavily doped diodes. The temperature coefficient in Zener diode is negative.

Zener breakdown occurs at a junction voltage of :

$$V_j = \frac{qw^2 N_d}{2\epsilon}$$

i.e. $w \propto \frac{1}{\sqrt{N_D}}$

It means doping is inversely proportional to the width of the depletion layer.

- (b) **Avalanche breakdown** : For lightly doped diodes, breakdown of diode is due to Avalanche i.e. rupture of covalent bond due to collision with high speed carriers. When electric field in depletion layer is very high it results in a very high velocity of minority carriers. Therefore, this phenomenon is observed at high voltage.

Avalanche breakdown is possible only above 6V. The temperature coefficient of Avalanche diode is positive.

1.3 SPECIAL DIODES

1.3.1 Zener Diode

This is similar to PN junction diode except that it is used in reverse bias only, because it has sharp breakdown at reverse bias as shown below :

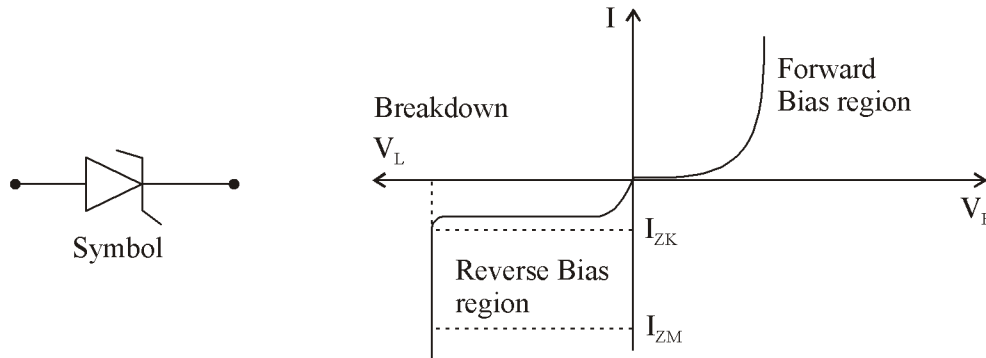

The breakdown voltage of a zener diode is carefully controlled by doping level during manufacturing. Forward characteristic of zener diode is exactly similar to PN junction but there is some interesting point in reverse bias as clear from V-I characteristic. These points are :

(i) **Breakdown voltage V_Z** : If the reverse voltage is applied then the voltage beyond which the current increases abruptly is called breakdown voltage. This is the voltage at which regulation is achieved when the diode is being used as a regulator.

(ii) **I_{ZK}** : This is the minimum value of current in reverse biased condition in order to keep the diode in reverse bias region.

(iii) **I_{ZM}** : Maximum value of zener reverse current above which diode may be damaged.

Zener Diode Specification : Power dissipation $P_Z = V_Z \times I_Z$

$$\text{Power rating of zener diode} = P_{ZM} \quad \text{and} \quad I_{ZM} = \frac{P_{ZM}}{V_Z}$$

Zener Diode Equivalent Circuit

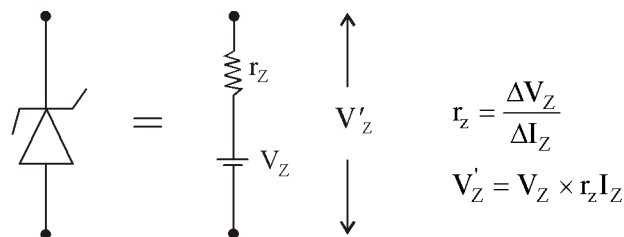

Application

- (i) As a voltage regulator.
- (ii) As a fixed reference voltage in transistor biasing.
- (iii) As a limiter in wave shaping circuits.
- (iv) For a meter protection.
- (v) The electron hole pair generates which increases the free electron to take part in conduction.

1.3.2 Photo Diode

Photo diode is a two terminal device which operates on reverse bias. Principle of operation is photo conductive effect. It has a small transparent window, which allows light to strike the PN junction. When there is dark current it means no radiations.

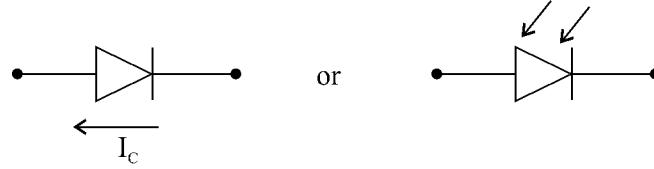

In reverse bias condition in the absence of light the reverse current through diode is very small like ordinary diode. But as soon as light is made to fall on the junction a large amount of current flows and the diode is forward biased.

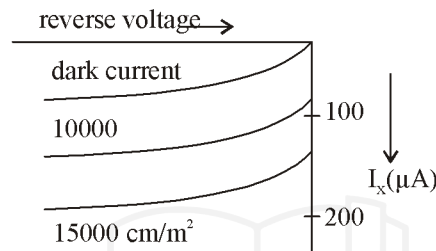

It is noticed from the characteristic above that the variation in resistance can be achieved with variation in light intensity to fall on diode.

Application

- (i) Photo detection
- (ii) Demodulation
- (iii) Logic circuits
- (iv) Switching
- (v) Optical Communication system
- (vi) Character recognition etc.

Note : Photovoltaic cell is a special application of Photo Diode.

1.3.3 LED (Light Emitting Diode)

PN junction which emits light when forward biased are called light emitting diode. It work on the principle of electro- luminescence.

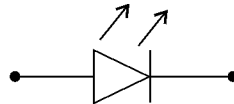

Only difference between LED and PN junction diode is of the material used for manufacturing LEDs.

	Material	Light emitted
(i)	Gallium Arsenide (GaAs)	Infrared radiation
(ii)	Gallium arsenide phosphide (GaAsP)	Red or yellow
(iii)	Gallium phosphide (GaP)	Red or green
(iv)	Gallium nitride	Blue light

Application

- (i) In 7 or 16 segment display.
- (ii) Indicating ON/OFF condition in power switch or stereo amplifiers.
- (iii) In optical switching applications.
- (iv) In the field of optical communication to transfer energy from one circuit to another circuit.
- (v) For image sensing circuits.
- (vi) Infra red LEDs has application in burglar alarm system.

Advantages

- (i) LEDs are of small size.
- (ii) Light output is function of current through it, so the intensity can be easily controlled.
- (iii) LEDs are highly efficient EM radiator.
- (iv) LED are very very fast device, switching time is less than 1n sec.
- (v) Low power requirement.

1.3.4 Schottky Diode

It is formed by joining a doped semiconductor region with a metal such as gold, silver or platinum.

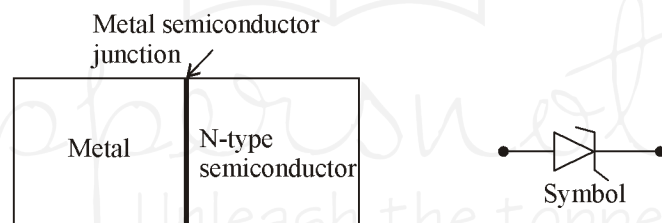
**Few Important points about Schottky diode :**

- (i) Schottky diode is a metal to semiconductor junction.
- (ii) Schottky diode only operates with majority carrier.
- (iii) Semiconductor used is usually N-type.
- (iv) It does not have any charge storage, therefore it is very fast.
- (v) Semiconductor region is lightly doped.

Applications

- (i) To rectify very high frequency.
- (ii) As a switching device in digital computers.
- (iii) In clipping and clamping circuits.
- (iv) Low power Schottky transistor transistor logic.
- (v) In low voltage power supply circuit.

1.3.5 Characteristic of Different Diodes

Device	Principal	Biasing	Application
Zener diode	Operates in breakdown region	Reverse bias	Voltage regulator
LED	Emits non coherent light	Forward bias	DC or AC indicators
Photodiode	Light produces minority carriers	Reverse bias	Light detectors
Optocoupler	Combines LED and photodiode	-	Input/output isolators
Laser diode	Emits coherent light	-	CD players, broadband communication
Schottky diode	Has no charge storage	-	High-frequency rectifiers (300 MHz)
Varactor diode	Acts like variable capacitance	Reverse bias	TV and receiver tuners
Varistor	Breaks down both ways	-	Line spike protectors
Step recovery diode	Snaps off during reverse conduction	-	Frequency multiplier
Back diode	Conducts better in reverse	-	Weak signal rectifiers
Tunnel diode	Has a negative resistance region	Forward bias	High frequency oscillators

1.4 CLIPPERS

Clipper is a special network of diodes, which clip-off a portion of the input signal without disturbing the unclipped part of the signal. Clippers can be divided in two categories as Series clippers and Shunt or parallel clippers.

1.4.1 Series Clippers :

A vast variety of series clipper exist. Some of them are following :

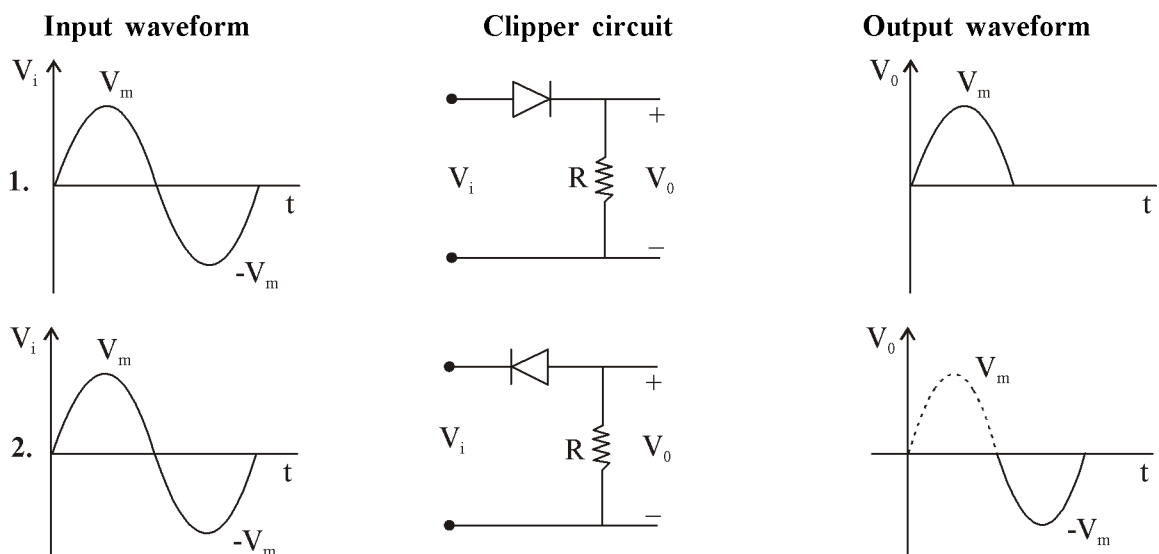

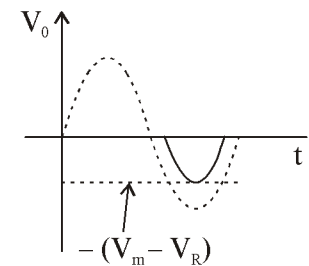
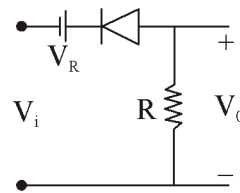
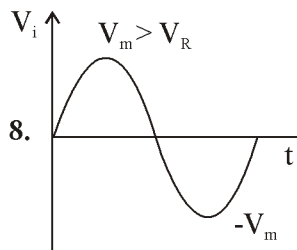
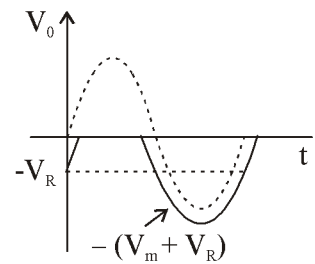
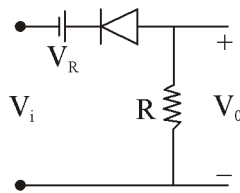
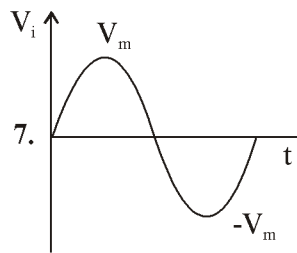
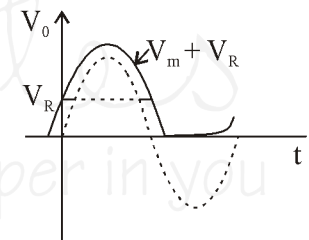
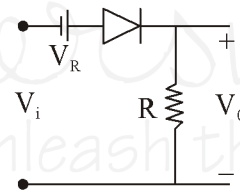
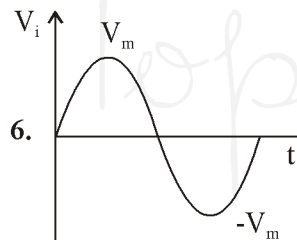
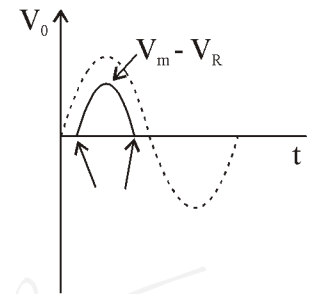
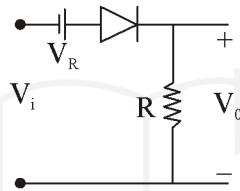
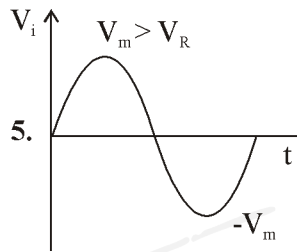
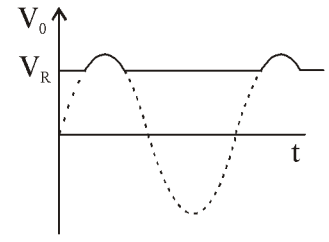
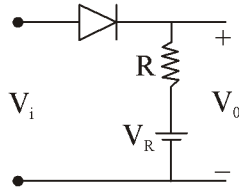
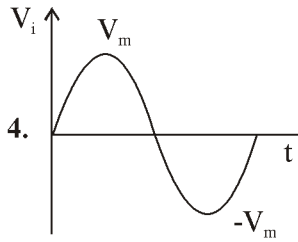
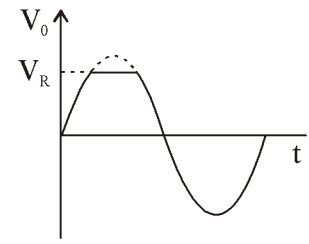
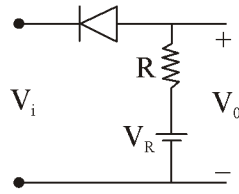
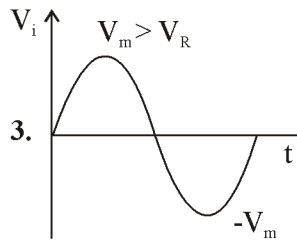

1.4.1 Shunt or Parallel Clippers :

A vast variety of shunt clipper exist. Some of them are as follows :

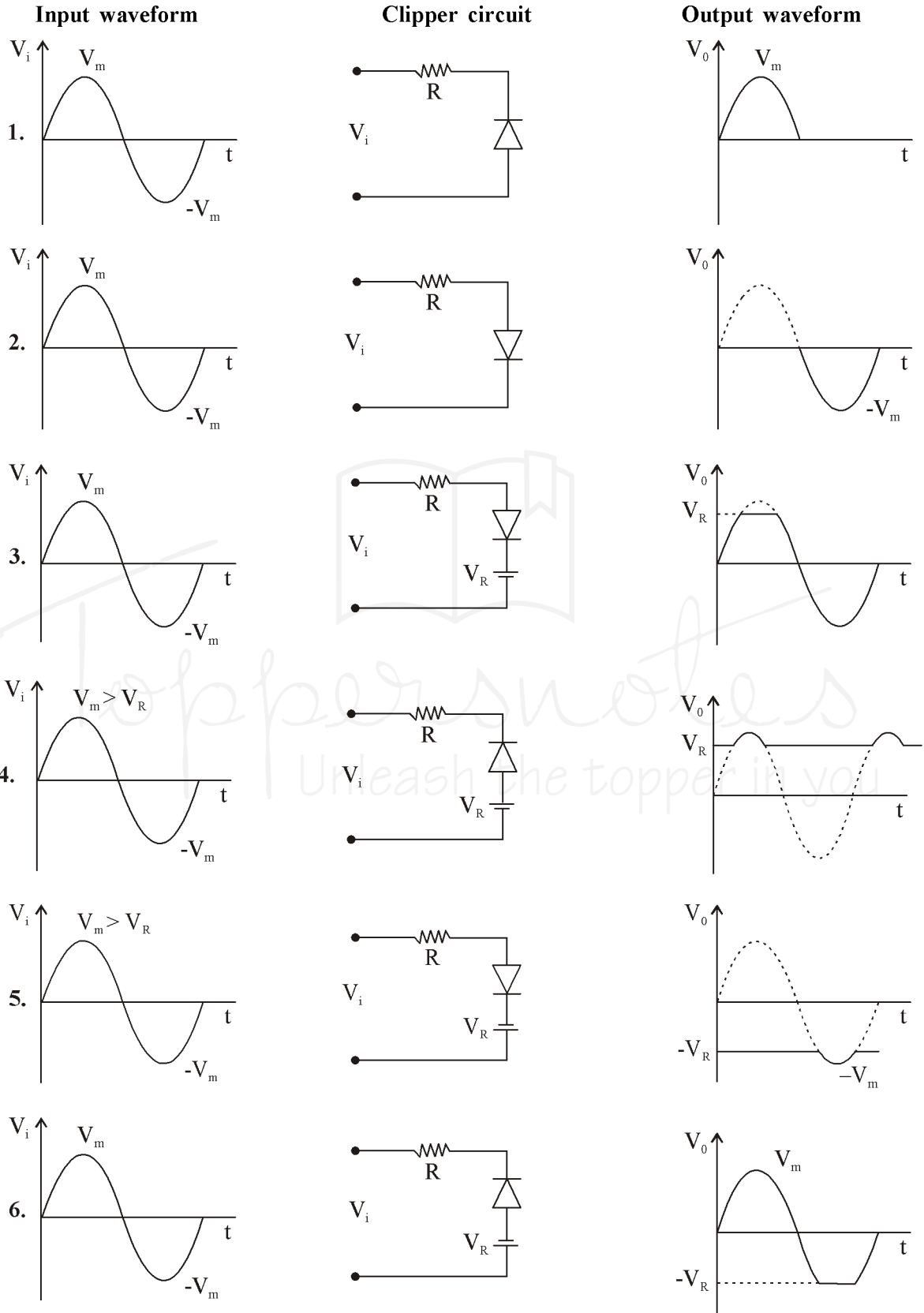

1.5 CLAMPERS

Clamping network consists of diode, capacitor and resistor and is used to shift the DC level of input signal. It must be noted that :

- (i) The total swing at the output of clamping network is equal to the total swing of the input signal.
- (ii) Analysis of clamper is started for that part of input signal for which diode is forward biased.

A vast variety of clamper circuits exists. Some of the them are as follows :

