



REASONING

For All Competitive Exams



Table of Content

S No.	Chapter Title	Page No.
1	English Alphabet Test	1
2	Series	10
3	Coding – Decoding	18
4	Analogy	24
5	Classification	29
6	Direction & Distance	32
7	Blood Relation	38
8	Clock	46
9	Seating Arrangement	51
10	Calendar	58
11	Mathematical Operations	61
12	Venn Diagram	65
13	Syllogism	71
14	Dice	78
15	Inserting the missing character number	81
16	Puzzle	83
17	Decision Making and Problem Solving	90
18	Statement and Conclusion	96
19	Mirror Image	102
20	Figure Series	106
21	Figure Analogy	110
22	Figure Classification	115
23	Figure Formation	118

Table of Content

S No.	Chapter Title	Page No.
24	Counting of Figures	121
25	Figure Completion	127

1 CHAPTER

English Alphabet Test

The English alphabet test is based on the English letters or alphabet being arranged in a certain format. In this test, questions are solved based on the formation of words by the selected letters, finding the letters in the pair of letters and between 2 letters, etc.

Some important facts related to the English alphabet.

1. Capital/Small letters of the English alphabet

Block letters	A B C D E
F G	
	H I J K L
M	
Lowercase letters	a b c d e f
	g h i j k l
m	
Block letters	N O P Q R
S T	
	U V W X Y
Z	
Lowercase letters	n o p q r
s t	
	u v w x y
z	

2. Vowels and consonants of the English alphabet

- (i) Vowel - There are 5 vowels in the English alphabet, which are as follows -
A, E, I, O, U

(ii) Consonants - There are 21

consonants in the English alphabet, which are as follows –

B, C, D, F, G, H, J, K, L, M, N, P, Q, R, S, T, V, W, X, Y, Z

3. The place of letters in the English - Alphabet is the first 13 and the last 13 letters of the alphabet are called the first and second half of the alphabet respectively. This location depends on two sequences.

(i) **First and second half of straight sequence** - In this sequence the letters from A to M are placed in the first half and the letters from N to Z are called the second half.
Left to Right

A	B	C	D	E	F	G	H	I	J	K	L	M
1	2	3	4	5	6	7	8	9	10	11	12	13
←						→						
<i>First Half</i>												

N	O	P	Q	R	S	T	U	V	W	X	Y	Z
14	15	16	17	18	19	20	21	22	23	24	25	26
←												
<i>Second Half</i>												

(ii) **The first second half of the opposite order** - In this sequence the letters from Z to N are called the first half and the letters from M to A are called the second half.

Z	Y	X	W	V	U	T	S	R	Q	P	O	N
1	2	3	4	5	6	7	8	9	10	11	12	13
←						→						
<i>First Half</i>												

M	L	K	J	I	H	G	F	E	D	C	B	A
14	15	16	17	18	19	20	21	22	23	24	25	26
←												
<i>Second half</i>												

4. Finding the Position Order of Letters by EJOTY and CFILORUX

from Left

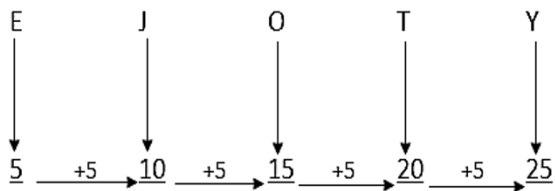

From Left

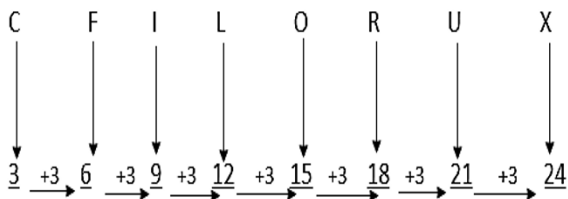

Opposite Letter - Each letter in the English alphabet has an opposite letter.

A	Z	$1 + 26 = 27$
B	Y	$2 + 25 = 27$
C	X	$3 + 24 = 27$
D	W	$4 + 23 = 27$
E	V	$5 + 22 = 27$
F	U	$6 + 21 = 27$
G	T	$7 + 20 = 27$
H	S	$8 + 19 = 27$
I	R	$9 + 18 = 27$
J	Q	$10 + 17 = 27$
K	P	$11 + 16 = 27$
L	O	$12 + 15 = 27$
M	N	$13 + 14 = 27$

If the letter of the English alphabet whose opposite letter is to be found, then the corresponding number of that letter is subtracted from 27. The number obtained after subtracting is the corresponding number of the opposite letter.

Finding the letter to the left and right of letters

- Whatever is on our right is the right of the same letters and whatever else is on

our left, is the left of those other letters. like -

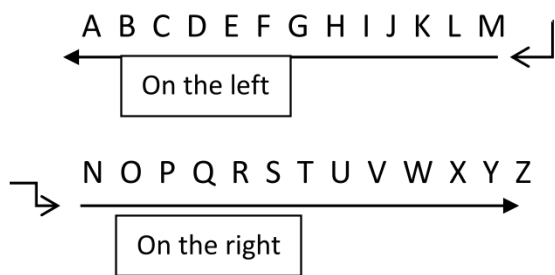

Question Types

Type-I Questions Based on Alphabet Test

1. The position of the letters in the direct sequence shall be -

Example-1 Which letter is 6th to the right of the sixteenth letter from the left in the alphabet A B C D E F G H I J K L M N O P Q R S T U V W X Y Z ?

- (a) F
- (b) Q
- (c) U
- (d) V

Ans. (d)

Solution - As per question

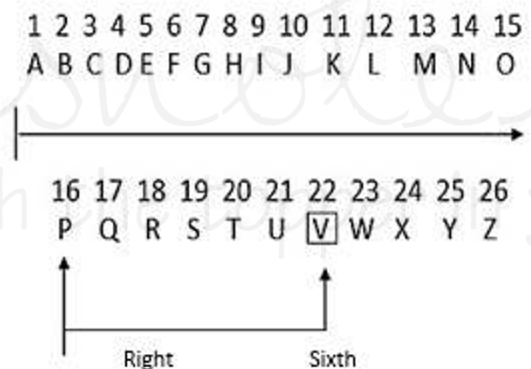

16th letter from left in English alphabet = P
Hence 6th letter to the right of P = V

Alternative Method

n^{th} letter to the right of m^{th} letter from left in English alphabet = $(m+n)^{\text{th}}$ letter from left.
 $m = 16$ and $n = 6$

$(16+6)^{\text{th}}$ letter from left = 22^{nd} letter from left = V

2. Position of letters in reverse order

Example - 2 If the English alphabet is written in reverse order, then which letter will be 13th to the left of the 3rd letter from the right?

- (a) C (b) P
(c) R (d) L

Ans. (b)

Solution - n^{th} letter to left of m letter from your right in reverse order of English alphabet = $(m + n)^{\text{th}}$ letter from right.

Here, $m = 3$ and $n = 13$

= $(3+13)^{\text{th}}$ letter from right = 16th letter from right = P Ans.

3. Position of letters in the first half of the reverse order

Under this, the first half of the letters of the English alphabet i.e. letters from A to M are written in reverse order and the remaining half of the letters are written as they are.

Example - 3

If the first half of the English alphabet is written in reverse order, then which letter will be to the left and seventh letter of the tenth letter from your right?

- (a) C (b) E
(c) D (d) J

Ans. (c)

Solution – According to question,

Solution – According to question,

13 12 11 10 9 8 7 6 5
M L K J I H G F E

4 3 2 1 14 15 16 17
D C B A N O P Q
↑ ← To the left of → ↑
7th 10th

18 19 20 21 22 23 24 25 26
R S T U V W X Y Z

← From the left of |

The 10th letter from the right is Q and the seventh letter to the left of the letter Q is D.

So required letter = D

4. Position of letters in reverse order of multiple letter segments

Example - 4

If the first four letters of the English alphabet are written in reverse order, then 5 letters also in reverse order, again 6 letters also in reverse order, 5 letters also in reverse order, again 6 letters also in reverse order, again If 7 letters are also written in reverse order and remaining letters are also written in reverse order, then which letter will be the seventh letter to the left of the eighth letter from the right?

- (a) O (b) L
(c) N (d) M

Ans. (d)

4 3 2 1 9 8 7 6 5 15 14
 D C B A I H G F E O N

13 12 11 10 22 21 20 19
 M L K J V U T S
 From left 7th 8th

18 17 16 26 25 24 23
 R Q P Z Y X W

From right 7th

As per question,

The eighth letter from the right is S and the seventh letter to the left of the letter S is M. So required letter = M

5. Number of letters between 2 letters -

Example - 5

How many letters are there in the middle of the eighth letter from the left and the seventh letter from the right in the English alphabet?

- (a) 8
- (b) 9
- (c) 10
- (d) 11

Ans. (d)

Solution – As per Question

1 2 3 4 5 6 7 8
 A B C D E F G H

↑
 eighth from left

Eight from left

9 10 11 12 13 14 15 16 17 18 19
 I J K L M N O P Q R S

11 letter

Letter

20 21 22 23 24 25 26
 T U V W X Y Z

↑
 7th
 from right

From right

Hence, the eighth letter from the left is H and the seventh letter from the right is T and there are 11 letters in between these two.

6. Same position of letters when arranged alphabetically -

Example - If each letter in the word CADMP is arranged alphabetically, then the positions of how many letters will remain unchanged.

- (a) 1
- (b) 2
- (c) 3
- (d) 4

Ans. (c)

Solution

<i>Root Word</i>	C	A	D	M	P
<i>Alphabetical Order</i>	A	C	D	M	P

Hence such letters are D, M, and P.

Type-2 Letter- Pair Based Question

If there are as many letters between two letters of a word as there are between them in the English alphabet, then the pair thus formed between those two letters is called a letter pair.

5 24 5 3 21 20 9 15 14
 E X E C U T I O N

Example - 7

How many such pairs of letters are there in the given word EXECUTION, which have as many letters between them in the word as there are between them in the English alphabet ?

- (a) 1
- (b) 2
- (c) 3
- (d) more than 3

Ans. (d)

Solution – According to question

So the required letter pair is UX, TU EI and NO i.e. 4.

Type - 3 Word Formation and Alphabet Arrangement

(i) Changing the letters of a meaningful word

Example - 8 If the letters of the first and second, third and fourth, fifth and sixth and so on are interchanged in the words, then what will be the tenth letter when counted from its right?

- (a) T (b) N
- (c) U (d) A

Ans. (b)

Solution - The word formed by interchanging the letters of the given word COMMUNICATIONS



Hence, the required alphabet = N

(ii) Making meaningful words from selected / consecutive letters of a semi-complete word

Example - 9 If anyone meaningful word can be formed from the first, third, fifth and eighth letters of the word SHARE HOLDING, then what will be its second letter? If no such word can be formed, give the answer 'X' and if more than one word can be formed, give the answer 'Y'

- (a) L (b) E (c) S
- (d) X (e) Y

Ans. (e)

Solution - The word given according to the question,

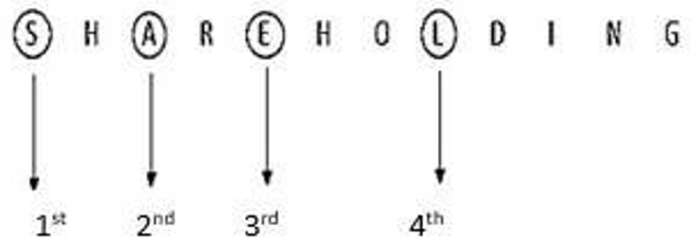

New word SEAL = SALE, SEAL = 2 Meaningful word Two meaningful words formed from it are SALE and SEAL, so option Y will be correct.

Example - 10 How many meaningful words with four or more letters can be formed from the letters of the word DIALOGUE ?

- (a) 5 (b) 7 (c) 9 (d) 8

Ans. (c)

Solution - words with four or more letters can be formed from the letters of DIALOGUE.

For Example - DIAL, GOAL, GOAD, GILD, GLUE, GUILD, LOUD, GUIDE, GUILLE etc.

(iii) Arrange the following numbers of different letters in such a way that a meaningful word is formed.

Example - 11

Arrange the numbers of different letters given below in such a way that a meaningful word is formed.

G	T	A	E	N	M
1	2	3	4	5	6

- (a) 1, 3, 2, 6, 4, 5 (b) 6, 3, 5, 1, 4, 2
- (c) 1, 3, 2, 5, 4, 6 (d) 6, 3, 1, 5, 4, 2

Ans. (d)

Solution - On arranging the given letters in a meaningful order, the word MAGNET is formed which is obtained by arranging the numbers in the order 6, 3, 1, 5, 4, 2.

Type - 4 Letter Group Based Questions

Under this, some groups of three or four letters are given in the questions asked. The answer is to be found by arranging these letter groups according to the instructions given in the question.

Example – 12

If the letter S is put before them in all the given words, then how many words in the new arrangement will make meaningful English words?

- (a) Only SHE
- (b) ANT and JUG
- (c) Only OLD
- (d) TIN and JUG
- (e) Only TIN

Ans. (c)

Solution - The following is the word in the new arrangement.

SHE, SOLD, SANT, STIN, SJUG

Hence in the given words, the letter S is preceded by only one meaningful word SOLD.

TYPE-5 RULE BASED ON INSTRUCTION

In this type of questions, related to English alphabets are given. Following these rules, it is to be seen that in which option the given letter is following the group.

Example - 13 A letter is missing between two letters.

- (a) EGIKM
- (b) MOQTU
- (c) MPQTU
- (d) MNOPQ

Ans. (a)

Solution -

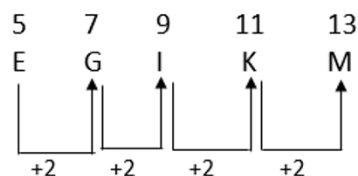

So in the EGIKM letter-pair, one letter is missed between every two letters.

Example - 14 English letters are in the reverse order of the alphabet.

- (a) ABCDE
- (b) ZYXWV
- (c) KLMNO
- (d) PQRST

Ans. (b)

Solution

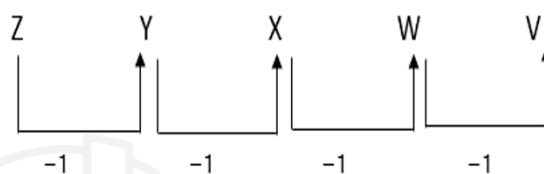

Hence, the letter pair Z Y X W V is in the opposite order of the alphabet.

Example with Solution

1. Which letter is exactly between the letters J and T in the English alphabet?

- (a) N
- (b) O
- (c) P
- (d) Q
- (e) None of the letter

Ans. (b)

Solution

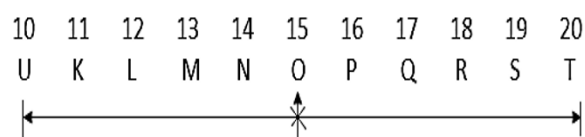

The letter O is exactly between J and T.

2. Which letter will be exactly between the 20th letter from the left and the 21st letter from the right in the English alphabet?

- (a) L
- (b) M
- (c) N
- (d) O
- (e) No letter

Ans. (b)

Solution

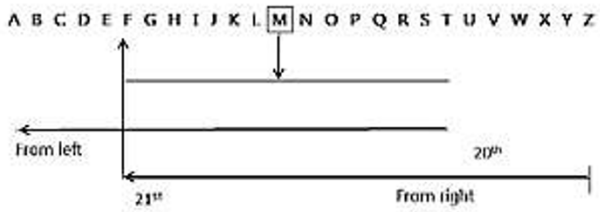

The 20th letter from the left is T and the 21st letter from the right is F and the letter M is exactly in between these two.

3. If the letters of the word BEAUTIFUL are rearranged and written alphabetically, then how many such letters will be there whose position will remain unchanged?

- (a) 1
- (b) 3
- (c) 2
- (d) more than three

Ans. (a)

Solution - According to the question,

<i>Root Word</i>	B E A U T I F U L
<i>Alphabetical Order</i>	A B E F I L T U U

Hence the position order of only one letter remains unchanged.

4. If each vowel of the word DOMAINS is changed to the letter that follows it according to the English alphabet and each consonant is changed to the letter that precedes it according to the English alphabet and then all the letters are alphabetically (from left to left) right), then which of the following will be at the third position from the right in the sequence so formed?

- (a) J
- (b) C
- (c) P
- (d) M
- (e) B

Ans. (d)

Solution

Given word → D O M A I
 N S

Changing the vowel → D P M B J
 N S

Changing the consonant C P L B J M R
 Now, alphabetizing these letters (from left to right)

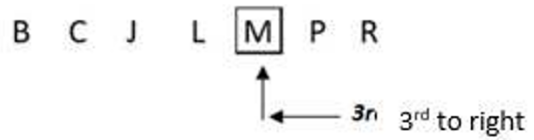

5. Make a meaningful word using each letter of the word HTUTR only once. Your answer will be the fifth letter of the word formed. If more than one such word is formed, then your answer will be wrong and if no such word is formed then your answer will be correct.

- (a) H
- (b) R
- (c) U
- (d) X
- (e) Y

Ans. (a)

Solution - According to the question, meaningful words formed from the letter-group HTUTR = TRUTH

Hence, the fifth letter from the left in TRUTH = H

6. What is the letter in the word WASHINGTON, which when counted is the same number as in the alphabet?

- (a) N
- (b) T
- (c) O
- (d) G

Ans. (d)

Solution - According to question



So required letter = G

7. A set of letters is assigned a number to each. Putting them in a meaningful order, select the correct sequence from the letters of the given answers.

Y M L O S B C I
 1 2 3 4 5 6 7 8

- (a) 47685321
- (b) 51264387
- (c) 21645387
- (d) 56241387

Ans. (b)

Solution - By rearranging the letters of Y M L O S B C I, the word S Y M B O L I C will be formed. So the correct order is 5 1 2 6 4 3 8 7.

8. In the following question, a word is given followed by four alternatives. Out of the four alternatives, only one option can be made from the letters of the given root word. Select that option.

V E N T U R E S O M E

- (a) ROSTRUM (b) TRAVERSER
(c) SERMON (d) SEVENTEEN

Ans. (c)

Solution - The word SERMON can be formed from the letters of the given word.

9. Which letter can be put after the words of the following questions to form new words ?

STAG, ENGAG, DAMAG, SEWAG

- (a) A (b) S
(c) E (d) P

Ans. (c)

Solution - If the letter E is placed immediately after the words STAG, ENGAM, DAMAG, SEWAG, then completely new meaningful words STAGE, ENGAGE, DAMAGE, SEWAGE will be formed.

10. The number of letters skipped between two adjacent letters is increased by multiples of two.

- (a) ADIPY (b) JMRYG
(c) EHNTC (d) HKBWF

Ans. (a)

Solution - The rule given in series A is being followed.

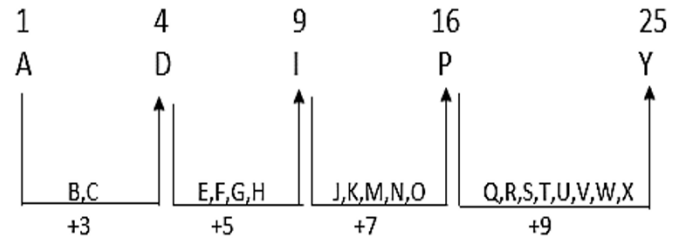

So, the desired series = ADIP

Practice Questions

TYPE - 1

- Q. 1** Cannot be formed using the letters of the given word.

VENTURE

- (a) RENT (b) RATE
(c) TURN (d) TRUE

- Q. 2** IMPOSSIONABLE

- (a) IMPOSSIBLE (b) POSSIBLE
(c) IMPOSE (d) IMPASSIVE

- Q. 3** KOLMOGROV - SMIRNOV

- (a) MOORINGS (b) ROOMKIN
(c) GOVINDA (d) SLIMGROOM

- Q. 4** DISINTEGRATION

- (a) SIGNATURE (b) INTERN
(c) SINGER (d) RATION

- Q. 5** COMPETITION

- (a) TOTEM (b) POETIC
(c) COMPOSE (d) OPINE

- Q. 6** TERRORISM

- (a) MIRROR (b) ERROR
(c) MORE (d) ROAR

- Q. 7** COMMUNICATION
 (a) ACTION (b) UNION
 (c) NATION (d) UNISON
- Q. 8** TRANSLATION
 (a) TRANSIT (b) TRANSMIT
 (c) RATION (d) NATION
- Q. 9** TECHNOLOGICAL
 (a) LOGIC (b) LOAN
 (c) HATER (d) COLOGNE
- Q. 10** EXAMINATION
 (a) MINE (b) TIME
 (c) SAME (d) NOTE
- Q. 11** From the following alternatives, select the word which cannot be formed using the letters of the given word.
 BUILDINGS
 (a) BUILD (b) BINDS
 (c) SAND (d) DUBS

- Q. 12** From the following alternatives, select the word which cannot be formed using the letters of the given word.
 COMPLIMENTARY
 (a) TRIM (b) TRAPS
 (c) PRIME (d) TRAIN
- Q. 13** From the following alternatives, select the word which cannot be formed using the letters of the given word.
 PROMINENT
 (a) TONE (b) MINE
 (c) PROPS (d) MORE
- Q. 14** From the following alternatives, select the word which cannot be formed using the letters of the given word.
 CONVICTED
 (a) CITE (b) NODE
 (c) TONE (d) DESK

Answer Key

Directions - Find out the related words from the alternatives given below.

- | | | | |
|-----------------|-----------------|-----------------|-----------------|
| Q.1 (d) | Q.2 (d) | Q.3 (c) | Q.4 (a) |
| Q.5 (c) | Q.6 (d) | Q.7 (d) | Q.8 (d) |
| Q.9 (c) | Q.10 (c) | Q.11 (c) | Q.12 (b) |
| Q.13 (c) | Q.14 (d) | | |

2 CHAPTER

Series



The series test series has to be studied carefully to find out whether this series is following the order/rule or not.

The questions asked under this test can be classified into the following categories.

1. Digit series
2. Alphabet series
3. Frequency Series of Digits/Characters

There are a few things to keep in mind while doing chain test.

- A. First try to play the whole chain.
- B. If the chain does not work, then we run it by laughing.
- C. At the very end run the alternate series

1. Digit series -

In this, a series of marks is given in the questions asked. This series is based on addition, subtraction, multiplication, division, square, square root, cube, cube root etc.

Type - (i) Finding the wrong term in the series.



In the series sequence, a wrong digit is added in place of the digit appearing at a particular place. For this, first of all it should be known that which term is not changing according to that rule, that is the wrong term.

Ex.1 Which number is missing in the following number series?

76, 98, 126, 160, 200, 248, 298

- (A) 248 (B) 200
(C) 160 (D) 298

Ans. (A)

Sol. After observing the above series carefully, we find that the sixth term of the series is inappropriate. Because the number to be added to each term is 6 digits more than its first number.

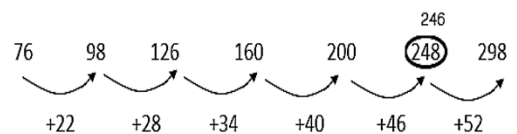

So instead of 248, there will be 246.

Ex.2 Which number in the following series is such that it is inappropriate in the series?

5, 3, 6, 10, 9, 12, 17, 15, 18, 23

- (A) 6 (B) 9
(C) 12 (D) 10

Ans. (D)

Sol. After observing the above series carefully, we find that the series is decreasing and increasing in the order of -2, +3, +5, -2, +3, +5,

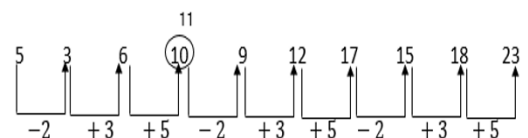

In the above series, 11 should come after the digit '6'. Hence the wrong number in the series is 10.

Directions: Question (1-7) Find the missing number in the following series.

Q.1 56, 42, 30, 20, ?, 6

- (A) 15 (B) 12
(C) 18 (D) 14

Ans. (B)

Explanation-

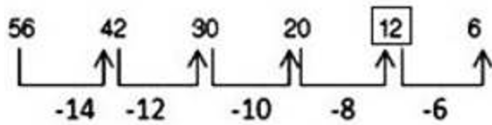

So, ? = 12

Q.2 1, 6, 15, ?, 45, 66, 91

- (A) 25 (B) 26
(C) 27 (D) 28

Ans. (D)

Explanation-

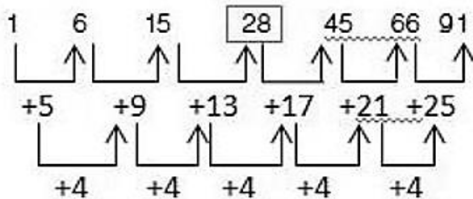

So, ? = 28

Q.3 1, 3, 7, 13, 21, 31, 43, ?

- (A) 55 (B) 57
(C) 59 (D) 61

Ans. (B)

Explanation-

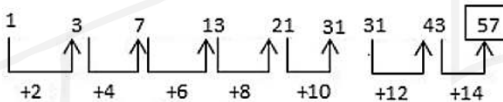

So, ? = 57

Q.4 0.5, 2, 4.5, 8, 12.5, ?

- (A) 17 (B) 16
(C) 16.5 (D) 18

Ans. (D)

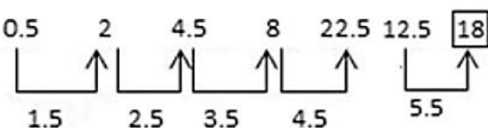

Explanation-

So, ? = 18

Q.5 3, 6, 18, 21, 63, 66, ?

- (A) 181 (B) 160
(C) 147 (D) 198

Ans. (D)

Explanation-

$3 + 3 = 6, 6 \times 3 = 18$

$18 + 3 = 21, 21 \times 3 = 63$

So, $63 + 3 = 66$

$? = 66 \times 3 = 198$

Q.6 510, 322, 404, ?

- (A) 422 (B) 371
(C) 629 (D) 819

Ans. (A)

Explanation -

There are even numbers in the sequence.

So, ? = 422

Q.7 32, 58, 92, 134, ?

- (A) 184 (B) 194
(C) 156 (D) 169

Ans. (A)

Explanation-

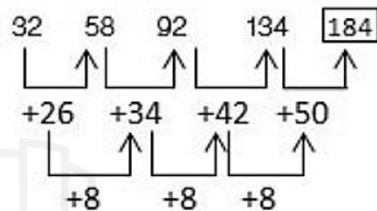

So, ? = 184

Type - (II)



Completing the series -

Under this, in the given series sequence, a particular place is left blank or is denoted by the question mark (?), then the candidates are expected to find that sequence and mark the question mark (?). Select the appropriate number to come in place of.

Ex.3 Which of the given number will come in place of question mark in the series?

16, 23, 31, 40, 50, 61, ?

- (A) 81 (B) 83
(C) 77 (D) 73

Ans. (D)

Sol. On observing the above series, we find that the series is increasing in the order of +7,+8,+9,+10.....



Therefore, the appropriate number to come in place of the question mark will be 73.

Ex.4 Which number will come in the question place in the above series?

5a 4a 15a 7a 23a 11a 29a 16a 33a g

- (a) 11 (b) 22
(b) 29 (d) 34

Ans. (B)

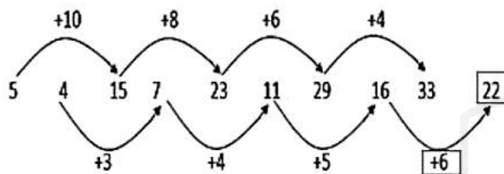

Therefore, the appropriate number to come in place of the question mark will be 22.

Type – III based on series rule

There are 2 types of rules of the category based on the rule of the first category.

1. Arithmetic series
2. Geometric series

1. Arithmetic Series - An arithmetic series is called a series in which the difference of two consecutive terms is equal.

The number obtained by subtracting the preceding term from a term of an A.P. is called 'transition'.

If there is the first post of the parallel category and the post is of the post, then there will be an parallel category.

Hence the nth term of the A.P. $T_n = a + (n-d)$ (1) d (where, a is the first term and d is the transition)

Ex.5 What will be the 10th term of 1st series 3, 5, 7, 9.....

- (A) 15 (B) 20
(C) 12 (D) 21

Ans. (D)

Sol. 10th term

$$T_n = a + (n-1) d$$

$$T_{10} = 3 + (10 - 1) \times 2$$

$$T_{10} = 3 + 18$$

$$T_{10} = 21$$

Hence the 10th term is 21

Ex.6 If the first term of an arithmetic sequence is 5, the second term is 3 and the last term is 80, then find the number of terms.

- (A) 24 (B) 23
(C) 26 (D) 29

Ans. (C)

Sol. $a = 5, d = 3, T_n = 80, n = ?$

$$T_n = a + (n - 1) d$$

$$80 = 5 + (n - 1) 3$$

$$(n - 1) = 80 - 5/3$$

$$n - 1 = 25$$

$$n = 25 + 1$$

$$n = 26$$

Hence the number of posts is 26

2. Geometric Series - Such a series in which the ratio of two consecutive terms is same is called 'Geometric Series'.

This ratio is called the 'common ratio' of the geometric series. The 'common ratio' of a geometric series is obtained by dividing a term by its previous term, i.e.

$$t_2/t_1 = t_3/t_2 = t_4/t_3 = \dots \dots \dots$$

$$= t_n/t_{n-1} = \text{proportionate}$$

$$t_1, t_2, t_3, t_4$$

The middle term is the average of both the terms.

$$t_2 - t_1 = t_3 - t_2 = t_4 - t_3$$

If the first term of a geometric series is a and the proportion is r , then the n th term of that geometric series

$$T_n = a \cdot r^{n-1}$$

Ex.7 What is the 6th term of the series **3,9,27,81,.....?**

- (A) 729 (B) 243
(C) 1681 (D) 1747

Ans. (A)

Sol. First Term $a = 3$

Common ratio $d = 9/3 = 3$

6th term $T_6 = a \cdot r^{n-1}$

$$= 3 \cdot 3^6 - 1$$

$$= 3 \times 3^5$$

$$= 3 \times 243 = 729$$

$$= 3 \times 243 = 729$$

So the 6th term is 729

Ex.8 What will be the 10th term of the series **7, 14, 28,..... ?**

- (A) 3216 (B) 2736
(C) 2684 (D) 3584

Ans. (D)

Sol. First Term $a = 7$

Common ratio $= 14/7 = 2$

10th term

$$T_{10} = a \cdot r^{n-1}$$

$$= 7 \times 2^{10-1}$$

$$= 7 \times 2^9$$

$$= 7 \times 512$$

$$= 3584$$

Hence the 10th term is 3584

Type-IV

Q.1 In the following questions, select the odd number pair from the given alternatives.

- (A) 10.30 (B) 11.33
(C) 50.150 (D) 13.37

Ans. (D)

Explanation-

Except the number pair 13-37, in all the other number-pairs, the second number is three times the first number.

$$10 \times 3 = 30$$

$$11 \times 3 = 33$$

$$50 \times 3 = 150$$

but,

$$13 \times 3 - 2 = 37$$

Q.2 In the following questions, select the odd number pair from the given alternatives.

(A) 18 : 37 (B) 24 : 47

(C) 32 : 65 (D) 48 : 97

Ans. (B)

Explanation-

Number pair 24: Except 47, in all other number-pairs, the second number is one more than twice the first number.

$$18 \times 2 + 1 = 37$$

$$32 \times 2 + 1 = 65$$

$$48 \times 2 + 1 = 97$$

but,

$$24 \times 2 - 1 = 47$$

3. Alphabet series -

Under this, a series of letters related to the English alphabet is given in the given series, in which one or two letters are omitted, or is represented by a question mark (?) in that place.

Ex.9 What will come in place of question mark (?) in the given series?

J K M P T ?

(A) X (B) W

(C) Y (D) none

Ans. (C)

Sol.

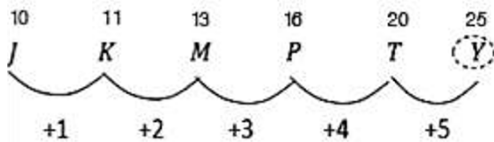

Hence the appropriate letter coming in place of question mark (?) will be Y.

Ex.10 L7C, N9F, P12I, R16L, ? What will come at the question mark in this series?

- (A) U21O (B) S21P
(C) S20O (D) T21O

Ans. (D)

Sol. Therefore, in place of the question mark (?), the appropriate number-letter group will be T21O.

Ex.11 What will come in place of the missing letters of the following series?

ab__baabc__aabcb__abcb__

- (A) bcaa (B) cbaa
(C) abca (D) aacb

Ans. (B)

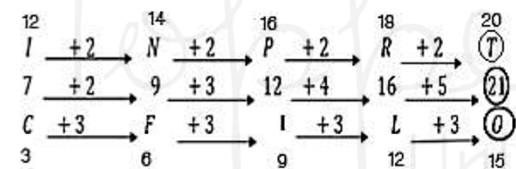

Q.1 In the following question, select the odd letters from the given alternatives.

- (A) mop (B) prs
(C) tvw (D) xyz

Ans. (D)

Explanation-

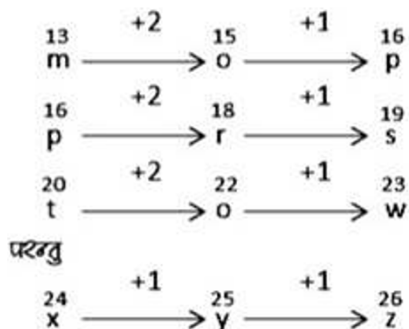

Q.2 In the following questions, select the odd letters from the given alternatives.

- (A) AB (B) EG
(C) IJ (D) OP

Ans. (B)

Explanation-

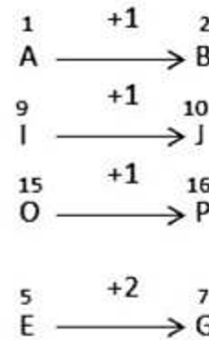

Q.3 In the following questions, select the odd letters from the given alternatives.

- (A) PM (B) DA
(C) RP (D) OL

Ans. (C)

Explanation -

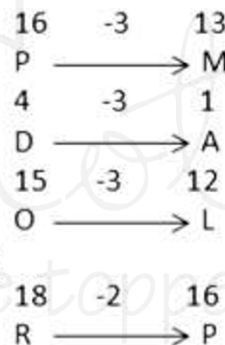

Q.4 In the following questions, select the odd letters from the given alternatives.

- (A) BLOP-OPBL (B) STIR-IRST
(C) CANT-NTCA (D) PEST-SEPT

Ans. (D)

Explanation-

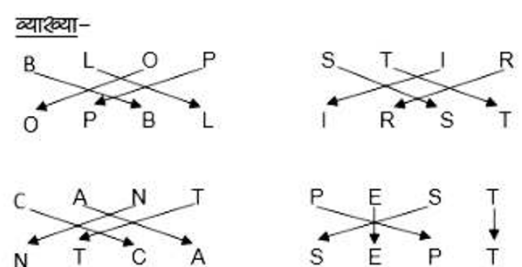

Q.5 In the following questions, select the odd letters from the given alternatives.

- (A) EI-LM (B) AE-RT
(C) IO-WY (D) OU-DF

Ans. (A)

Explanation –

'Letter-pair' is a letter gap between the letters of the second unit in all other letter-pairs except 'EI-LM'. The first unit has a continuous vowel.

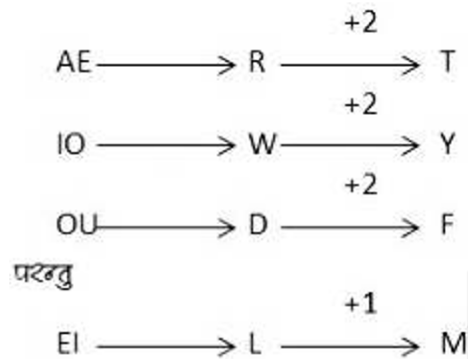

Q.6 In the following questions, select the odd letters from the given alternatives.

- (A) DEGJ (B) QRTW
(C) YZBE (D) JKNQ

Ans. (D)

Explanation -

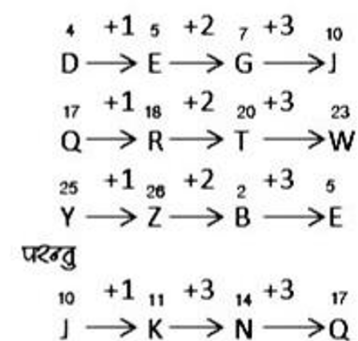

Q.7 In the following questions, select the odd letters from the given alternatives.

- (A) ACDF (B) TUOP
(C) HIVW (D) FGKL

Ans. (A)

Explanation -

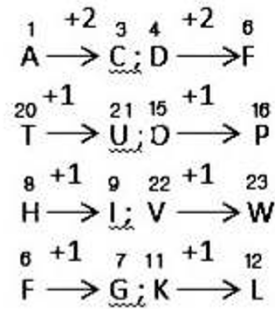

3. Frequency series of digits or letters -

Under this, the numbers or letters appear repeatedly in a certain sequence, thus forming a series of numbers / letters in which one or two digits in the middle or end or

Alphabets are lost and candidates have to find out the missing number/letters.

Ex.12 02487503001024875030010

- (A) 2,4 (B) 0,1
(C) 0,2 (D) 4,8

Ans. (A)

Sol. After looking carefully at the given series of numbers, we find that 02487503001 is appearing repeatedly in the sequence.

So the next two digits will be 2 and 4.

Directions: (1-7) Find the missing term in the following series-

Q.1 Y, S, N, J, G, ?

- (A) F (B) E
(C) H (D) I

Ans. (B)

Explanation-

Hence, the appropriate term coming in place of (?) will be E.

Q.2 NZ, OY, PX, QW, RV, ?

- (A) FS (B) SU
(C) UF (D) TU

Ans. (B)

Explanation-

Hence, the appropriate term will come in place of (?) will be SU.

Q.3 A, E, I, ?, Q

- (A) O (B) M
- (C) U (D) L

Ans. (B)

Explanation-

$$A \xrightarrow{+4} E \xrightarrow{+4} I \xrightarrow{+4} \boxed{M} \xrightarrow{+4} Q$$

Hence, the appropriate term to come in place of (?) will be M.

Q.4 a d c e b e d f c f e ?

- (A) h (B) g
- (C) f (D) d

Ans. (B)

Explanation-

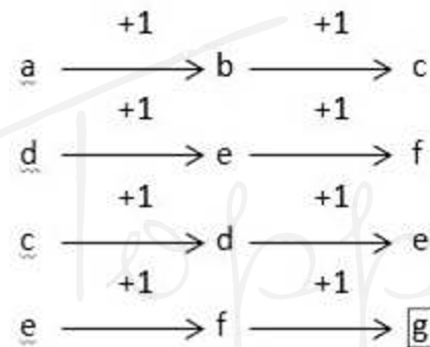

Hence, the appropriate term coming in place of (?) would be g.

Q.5 AAT, BBE, CCP, ?

- (A) DDA (B) DDB
- (C) DDC (D) DDD

Ans. (A)

Explanation-

$$\begin{array}{ccccccc}
 +1 & & +1 & & +1 & & \\
 A \rightarrow & B \rightarrow & C \rightarrow & \boxed{D} & & & \\
 +1 & & +1 & & +1 & & \\
 A \rightarrow & B \rightarrow & C \rightarrow & \boxed{D} & & & \\
 -15 & & -15 & & -15 & & \\
 T \rightarrow & E \rightarrow & P \rightarrow & \boxed{A} & & &
 \end{array}$$

Hence, the appropriate term to come in place of (?) will be DDA

Q.6 BC, GH, LM, ?

- (A) PQ (B) RS
- (C) QR (D) OP

Ans. (C)

Explanation-

$$\begin{array}{ccccccc}
 +5 & & +5 & & +5 & & \\
 B \rightarrow & G \rightarrow & L \rightarrow & \boxed{Q} & & & \\
 +5 & & +5 & & +5 & & \\
 C \rightarrow & H \rightarrow & M \rightarrow & \boxed{R} & & &
 \end{array}$$

Therefore, the appropriate term that comes in place of (?) will be QR.

Q.7 AC, FH, KM, PR, ?

- (A) UX (B) TV
- (C) UW (D) VW

Ans. (C)

Explanation-

$$\begin{array}{ccccccc}
 +5 & & +5 & & +5 & & +5 \\
 A \rightarrow & F \rightarrow & K \rightarrow & P \rightarrow & \boxed{U} & & \\
 +5 & & +5 & & +5 & & +5 \\
 C \rightarrow & H \rightarrow & M \rightarrow & R \rightarrow & \boxed{W} & &
 \end{array}$$

Hence, the appropriate term to come in place of (?) will be UW.

Q.8 In the following questions, select the odd number from the given alternatives.

- (A) 362 (B) 145
- (C) 26 (D) 625

Ans. (D)

Explanation-

Except the number 625, all other numbers are one more than the perfect square of certain natural numbers. The number 625 is a perfect square number.

362 = 19 × 19 + 1

145 = 12 × 12 + 1

26 = 5 × 5 + 1

But,

625 = 25 × 25

Practice Questions

1. **4, 10, 22, 46, ? Find the missing number.**
 (A) 56 (B) 66
 (C) 76 (D) 94
 2. **87, 90, 84, 88, 81, ?, ?**
 (A) 86,78 (B) 86,88
 (C) 86,88 (D) 85,93
 3. **Which of the following numbers is not correct in the sequence - 3, 6, 10, 16, 21, 28**
 (A) 10 (B) 3
 (C) 16 (D) 21
 4. **2, 12, 36, 80, 150, ? Find the missing number.**
 (A) 210 (B) 258
 (C) 252 (D) 194
 5. **Which of the following numbers is not suitable in the sequence? 19, 28, 39, 52, 67, 84, 102**
 (A) 84 (B) 102
 (C) 67 (D) 52
 6. **Find the missing letter**
 (A) WYAC (B) WXYA
 (C) WXYZ (D) WYZA
 7. **4E, 8I, 13N, 19T, ? Find the missing term.**
 (A) 26U (B) 26A
 (C) 26Z (D) 25X
 8. **ab__dbc__ __cda__d_bcab__d**
 (A) cdabac (B) cdaabc
 (C) adabac (D) dadabc
 9. **15, 30, 60, 120, ? Find the missing number.**
 (A) 250 (B) 245
 (C) 240 (D) 260
 10. **120, 60, 30, 15, ? Find the missing number.**
 (A) 7.5 (B) 5.7
 (C) 3.0 (D) 8.5
-
11. **4, 10, ? 82, 244, 730**
 (A) 218 (B) 28
 (C) 24 (D) 77

Answer Key

Directions - Find out the related words from the alternatives given below.

- | | | | |
|---------|----------|----------|---------|
| Q.1 (D) | Q.2 (A) | Q.3 (C) | Q.4 (C) |
| Q.5 (B) | Q.6 (A) | Q.7 (B) | Q.8 (A) |
| Q.9 (C) | Q.10 (A) | Q.11 (B) | |